

# Versuchung Jesu in der Wüste

2013 02 17 Evangelium Lukas 4,1-13

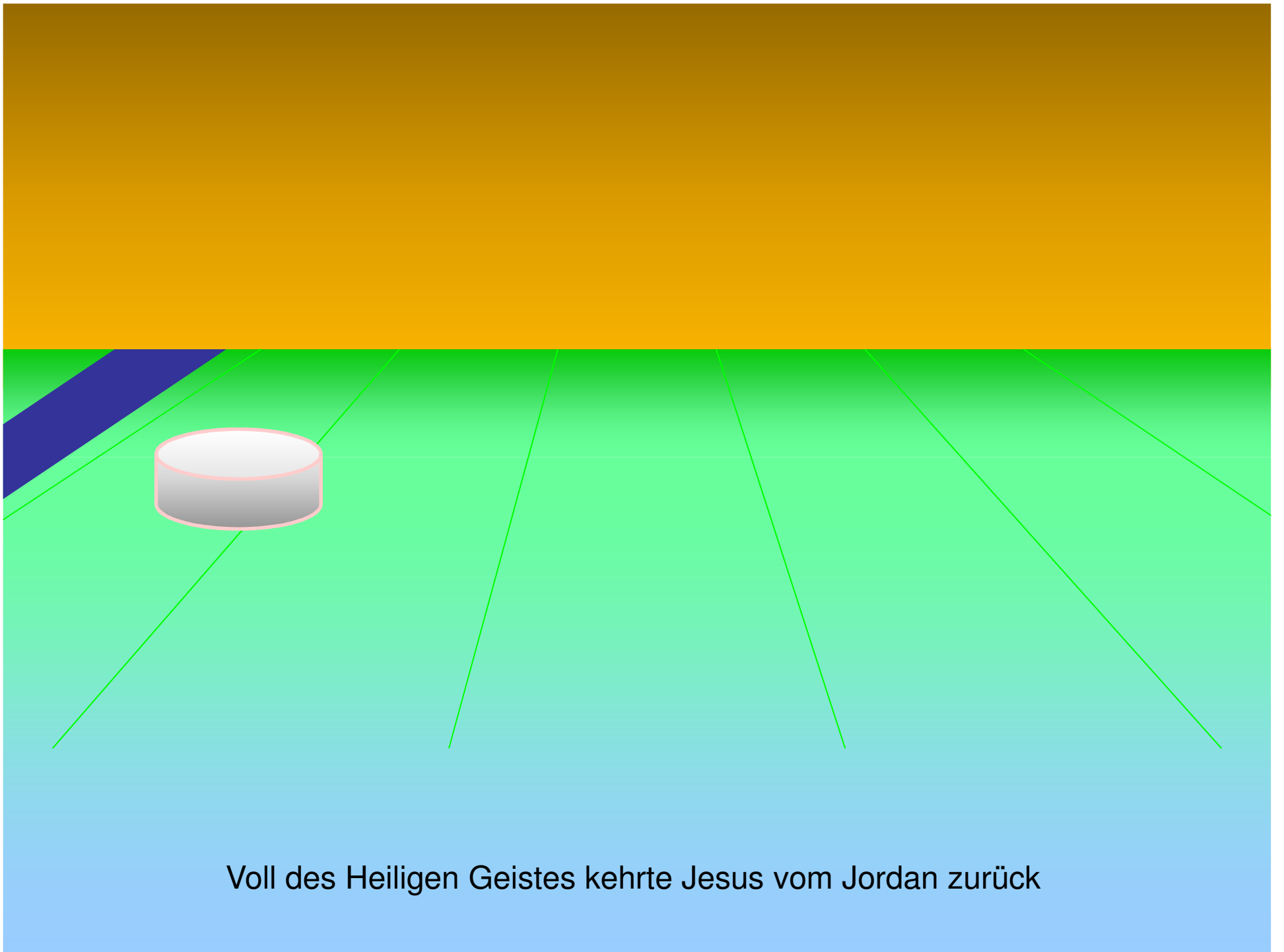

Voll des Heiligen Geistes kehrte Jesus vom Jordan zurück

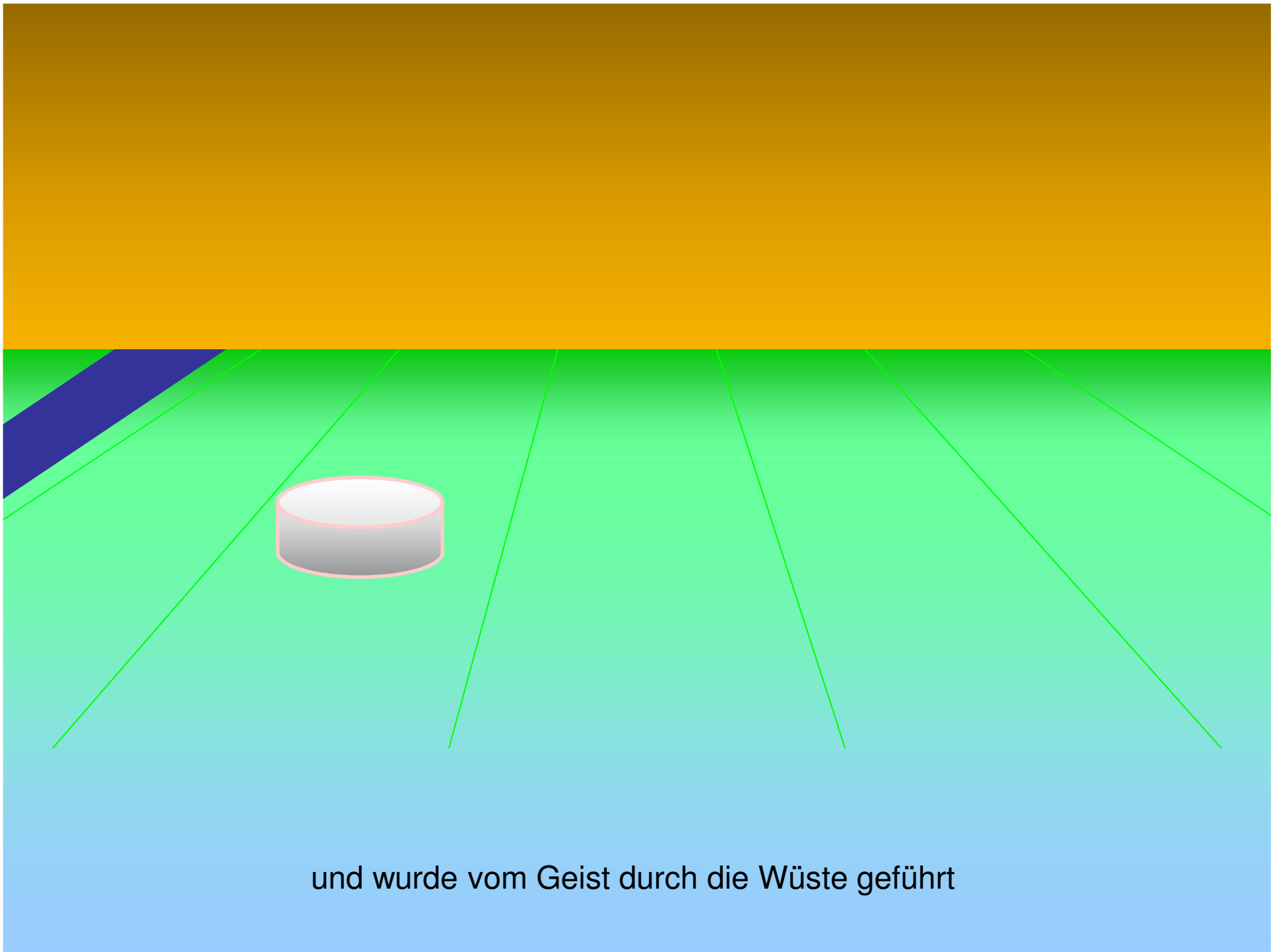

und wurde vom Geist durch die Wüste geführt

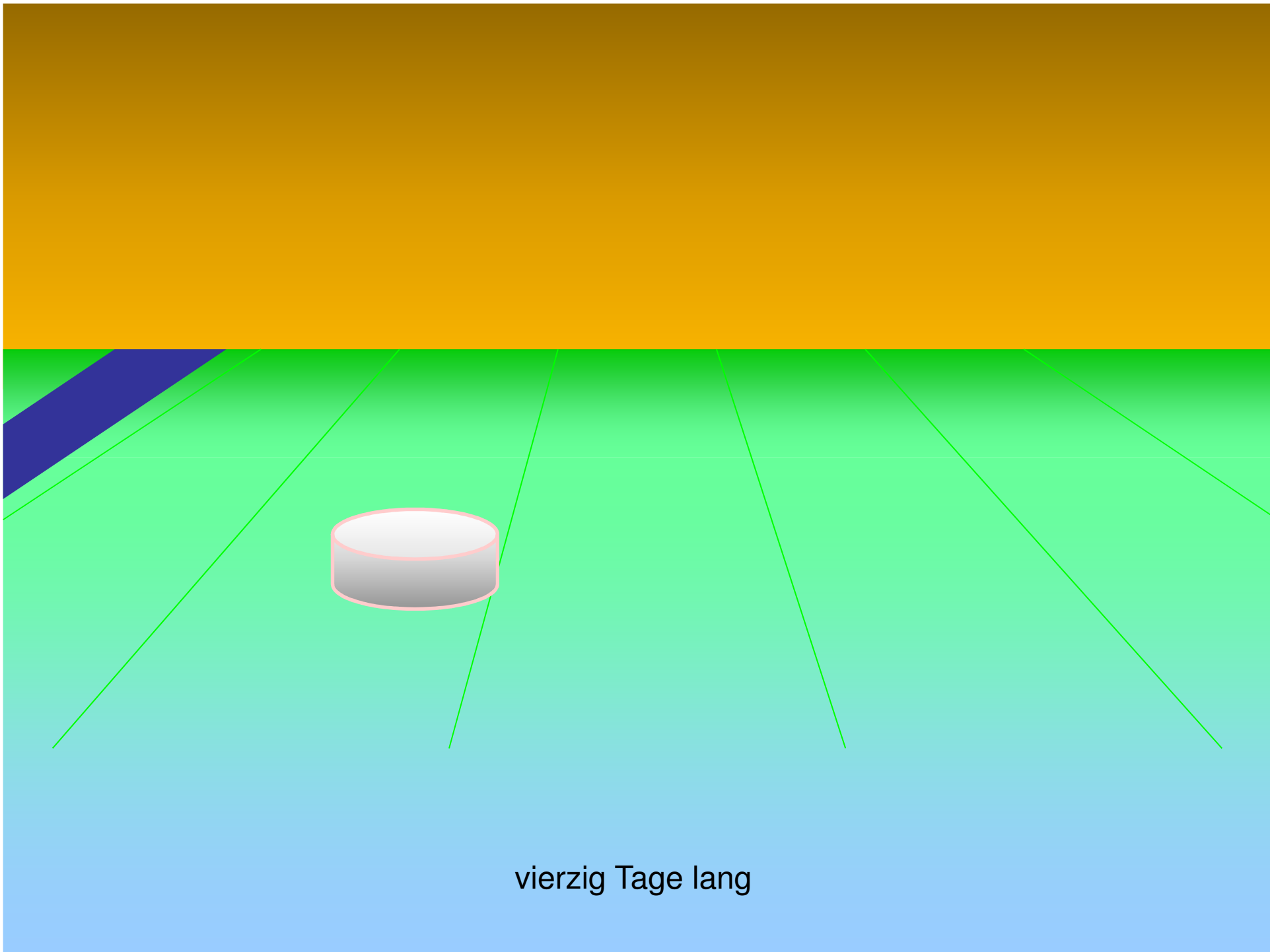

vierzig Tage lang

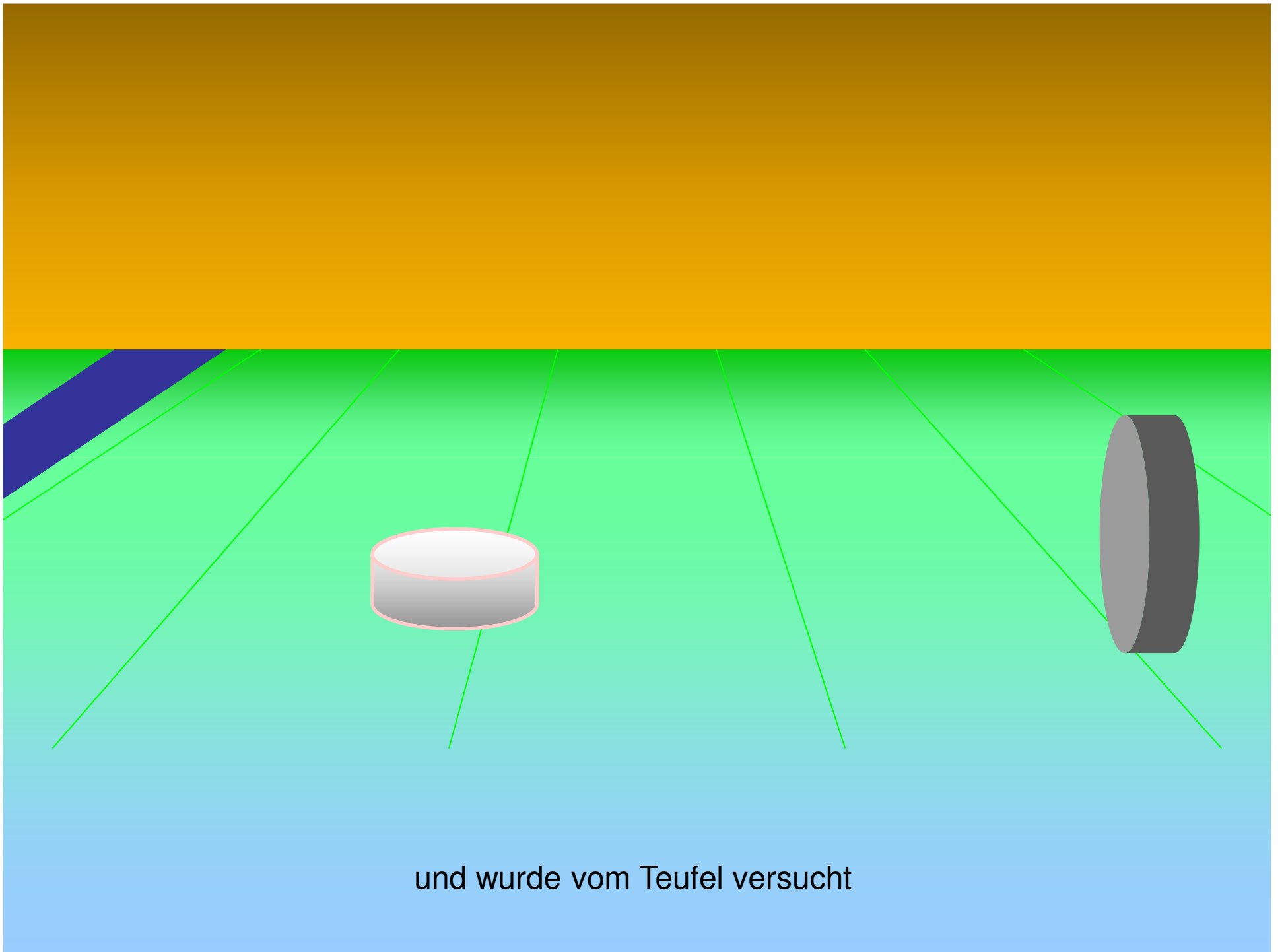

und wurde vom Teufel versucht

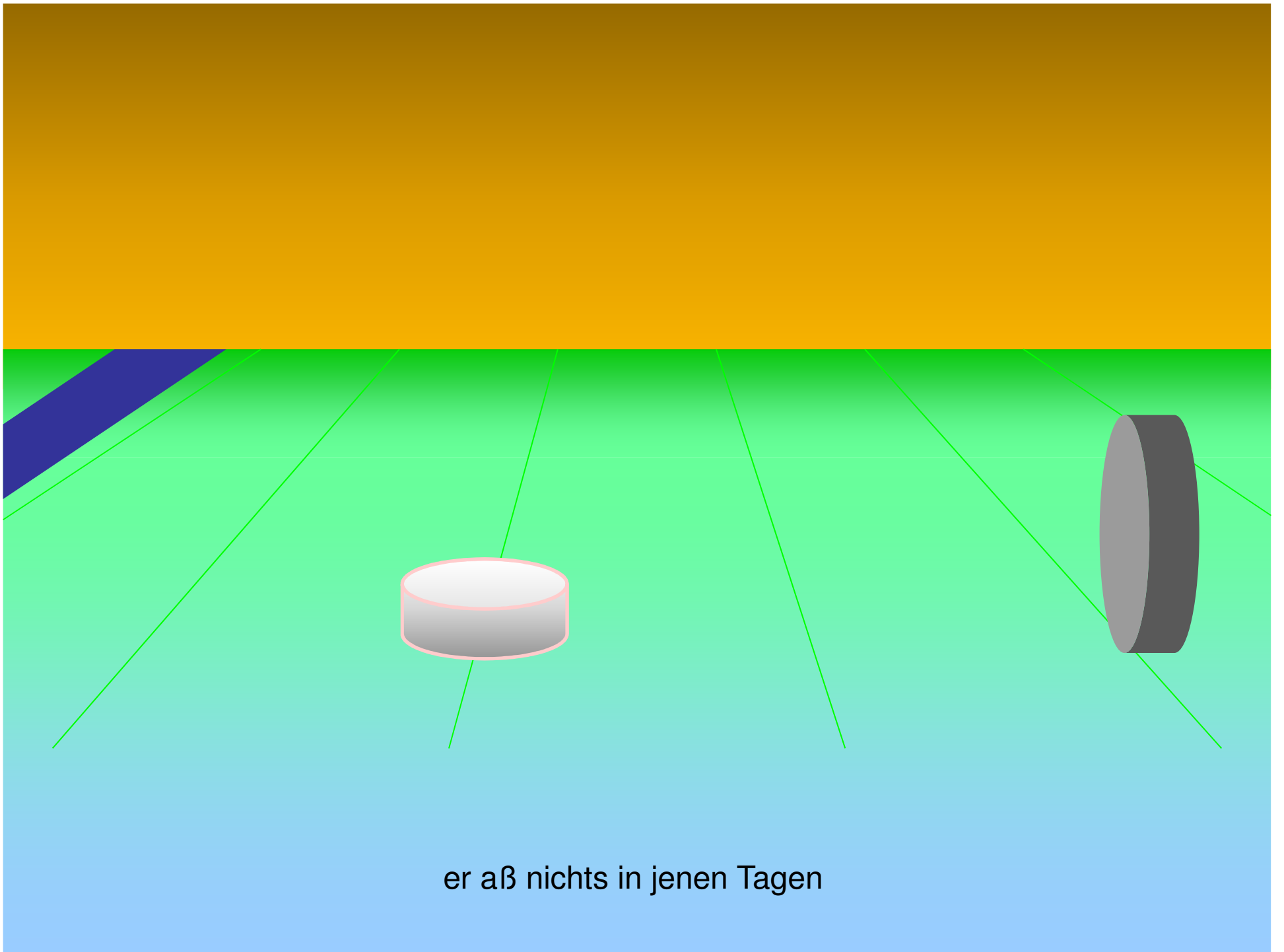

er aß nichts in jenen Tagen

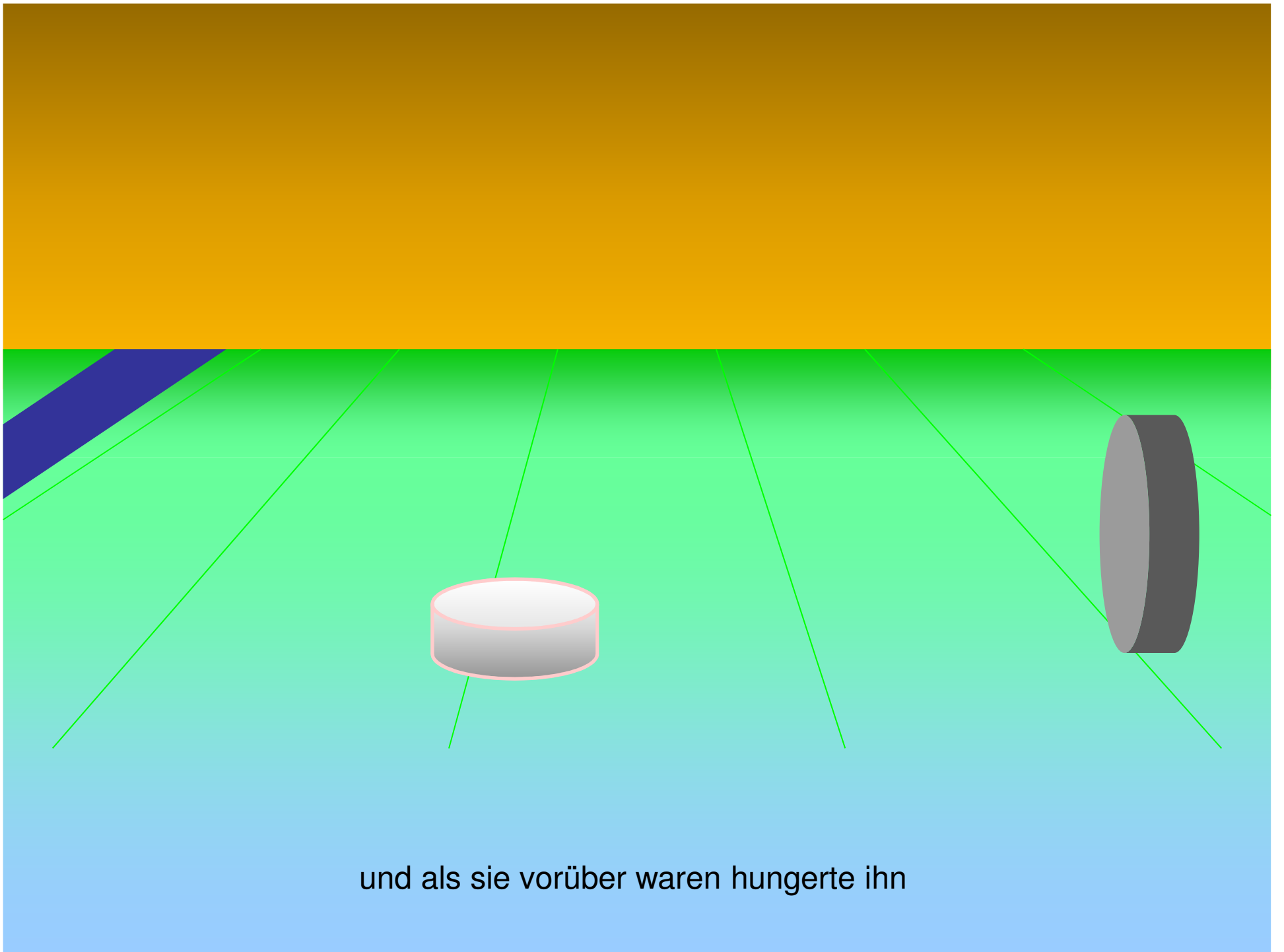

und als sie vorüber waren hungerte ihn

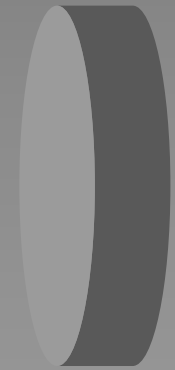
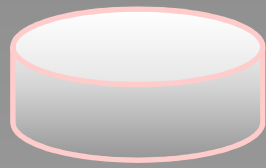

Da sprach zu ihm der Teufel:



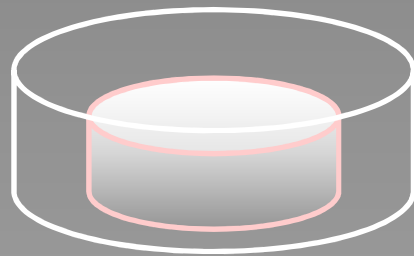

Wenn du Gottes Sohn bist

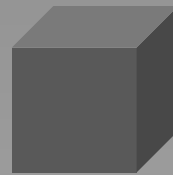
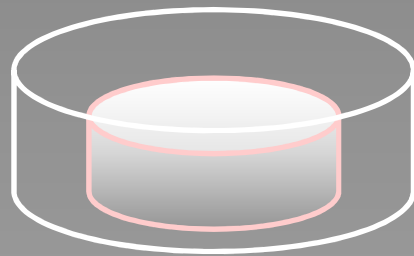

dann befiehl diesem Steine

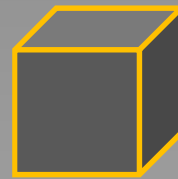
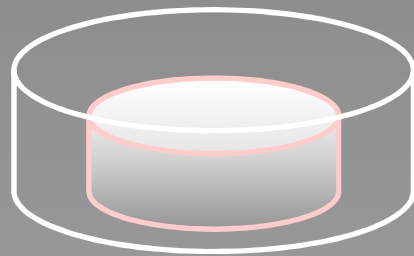

dass er Brot werde

Da antwortete ihm Jesus

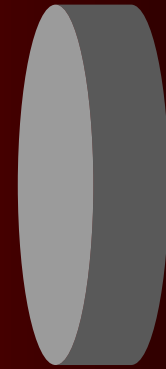
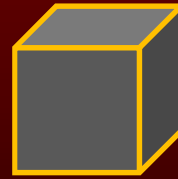
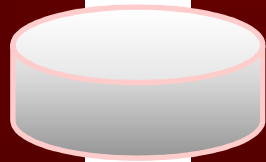

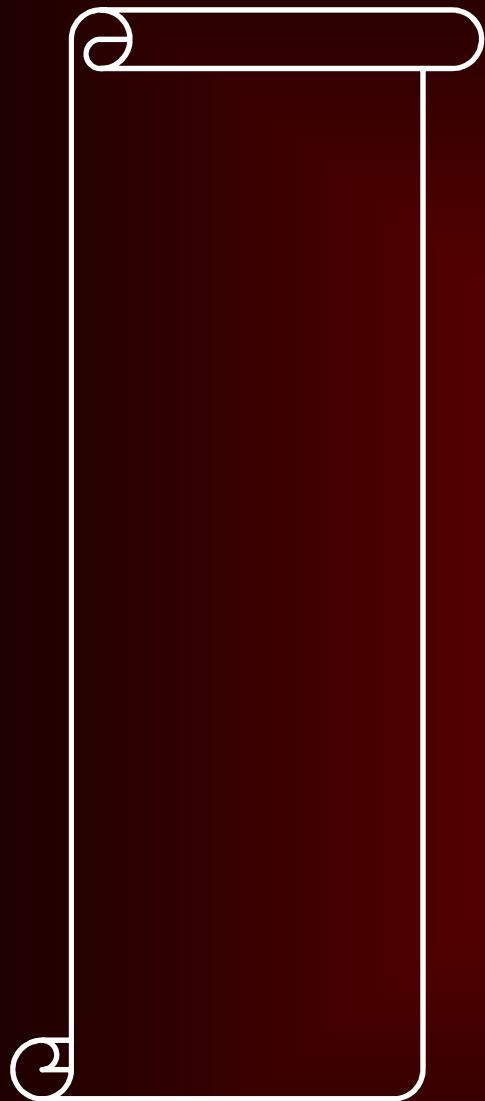

Es steht geschrieben

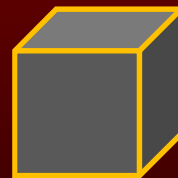
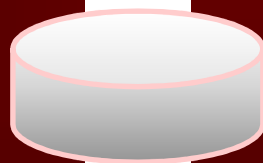

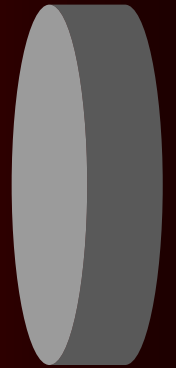
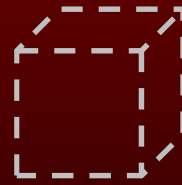
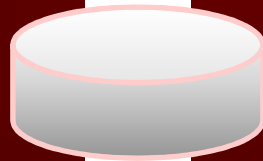
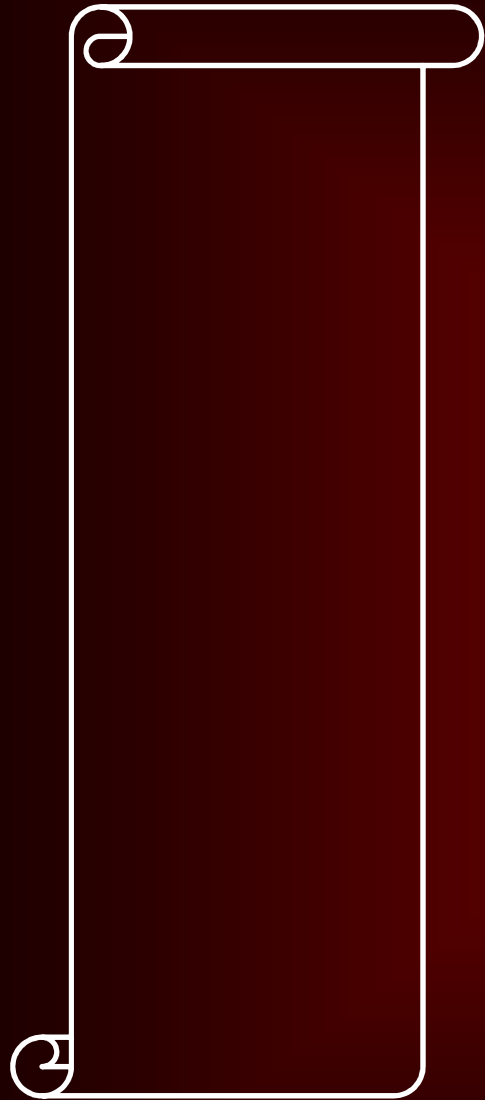

„Nicht vom Brot allein lebt der Mensch“

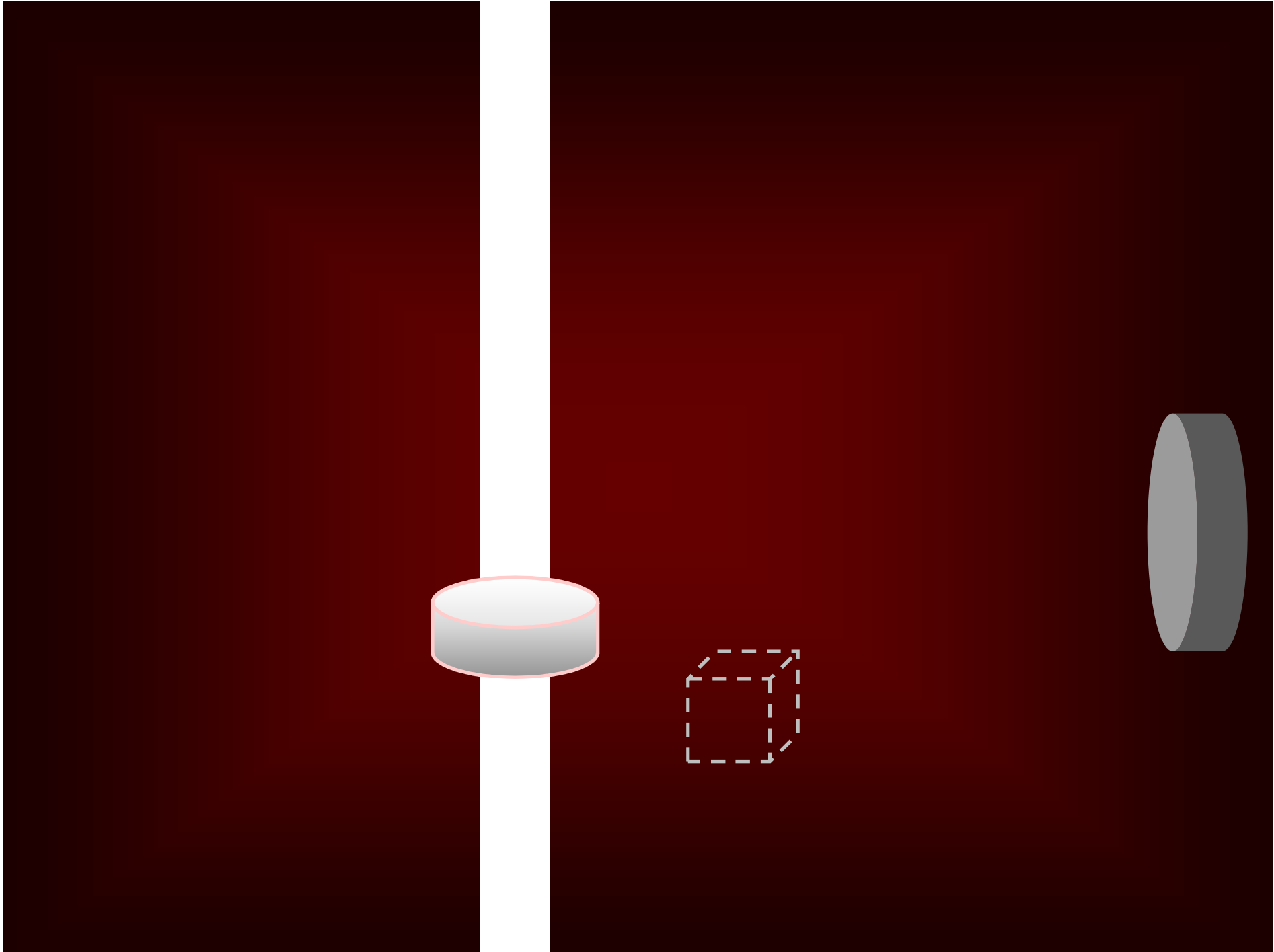

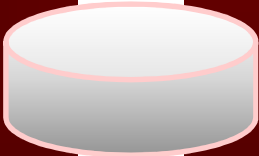
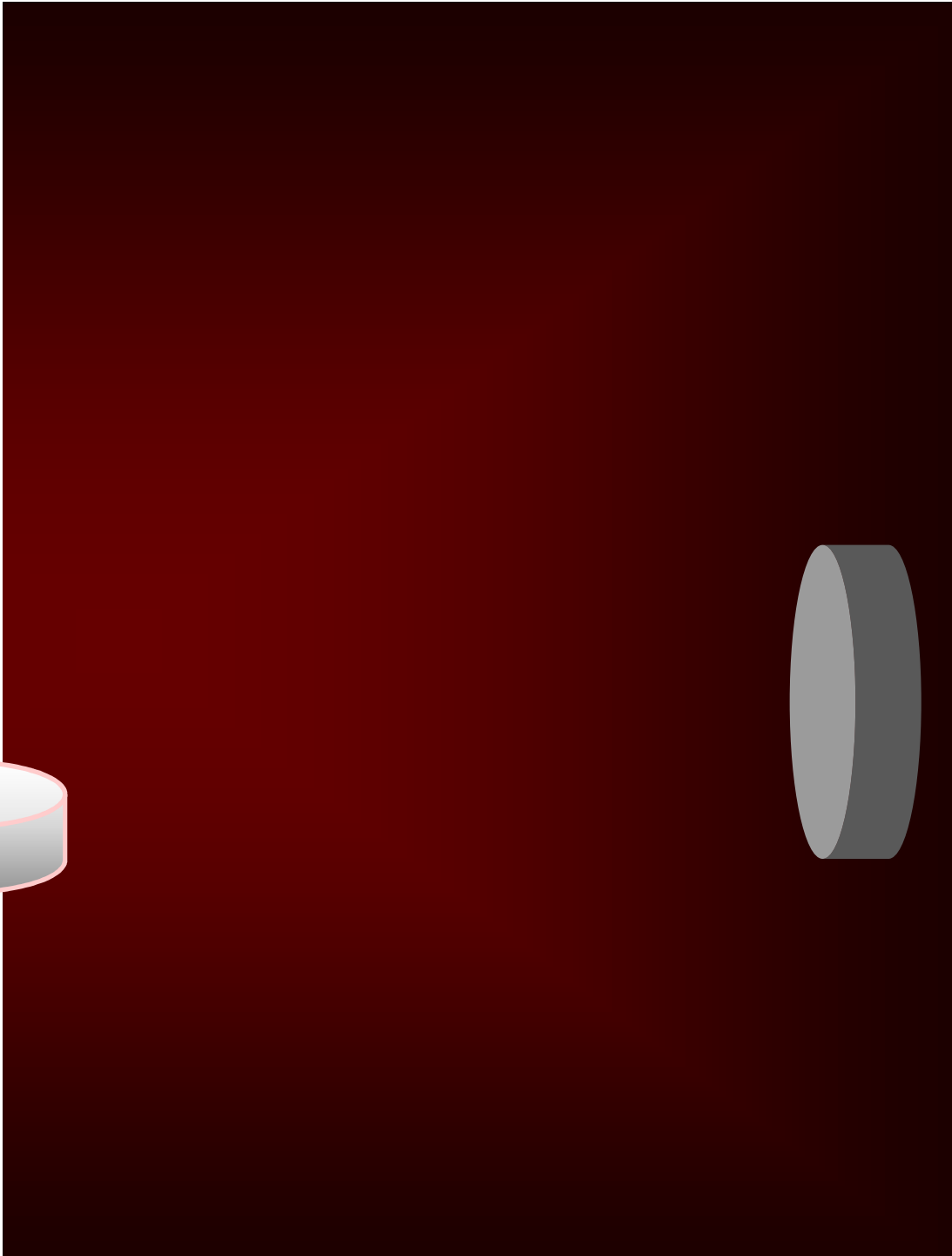



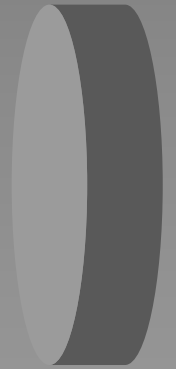
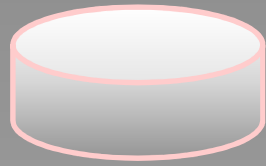

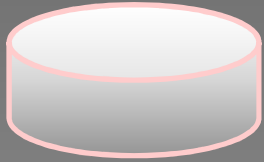

Dann führte er ihn hinauf

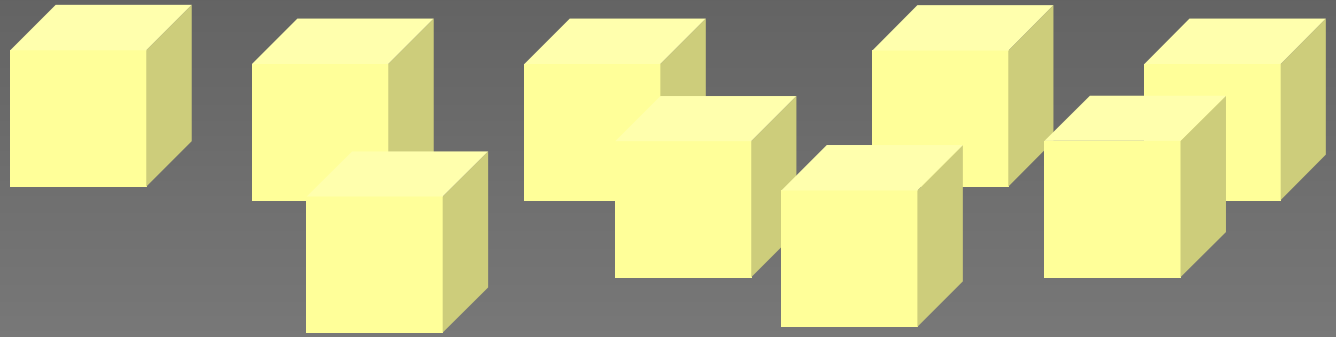
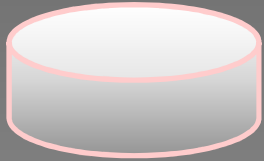

und zeigte ihm in einem Augenblick alle Reiche des Erdkreises

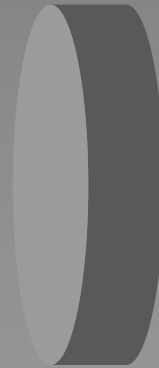
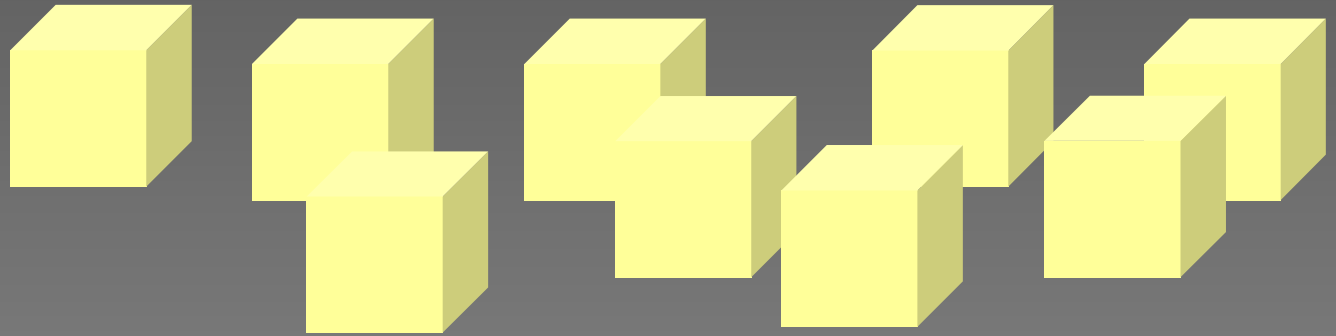
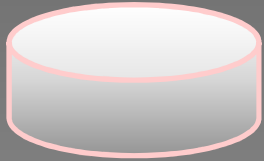

und der Teufel sagte zu ihm:

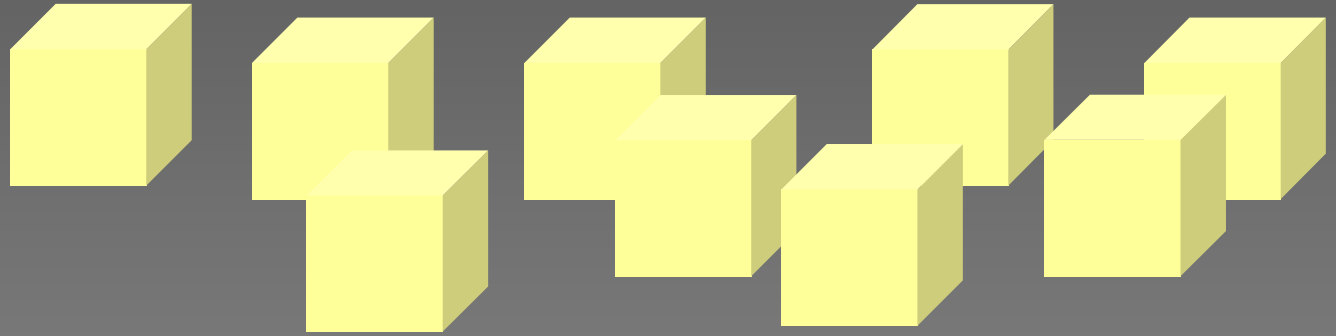
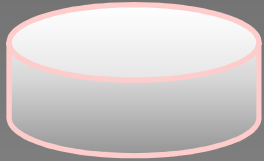

Dir will ich alle diese Macht und Herrlichkeit geben

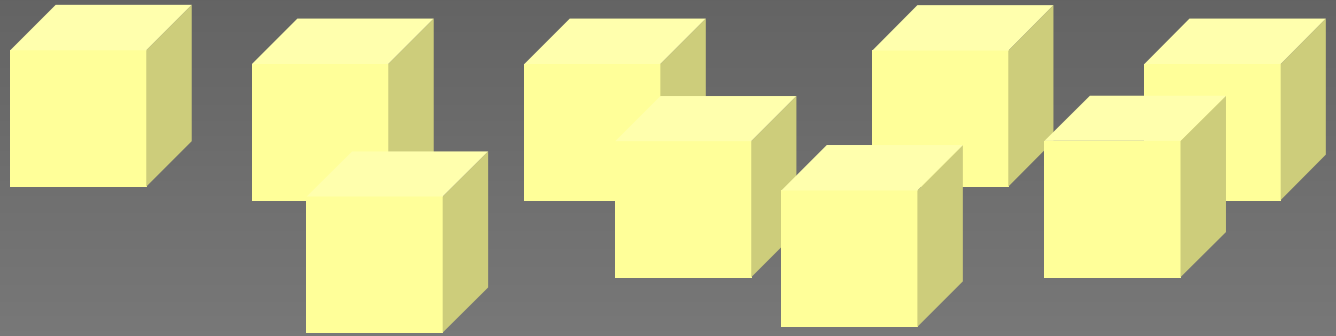
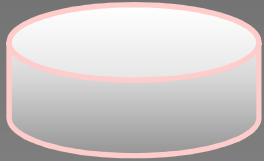

denn sie ist mir verliehen und ich gebe sie, wem ich will

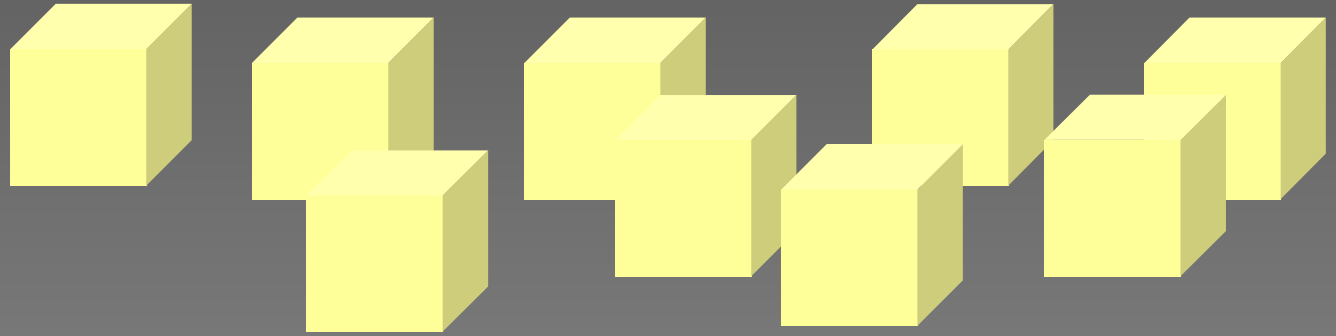
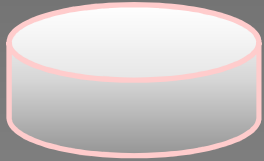

Wenn du also mir huldigst, soll sie ganz dein sein

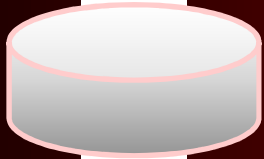

Da entgegnete ihm Jesus:



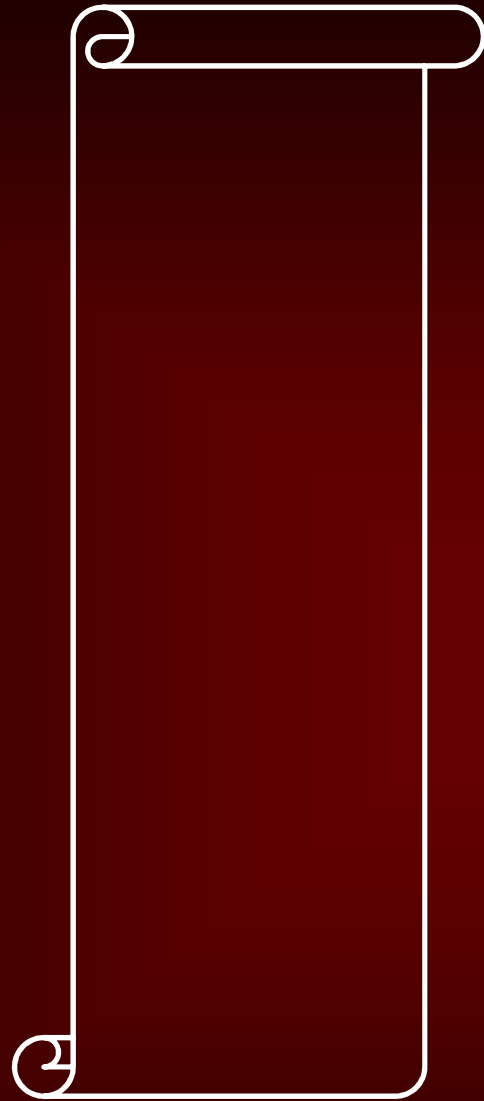
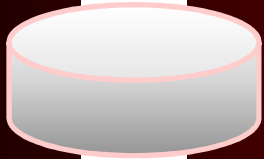

Es steht geschrieben:

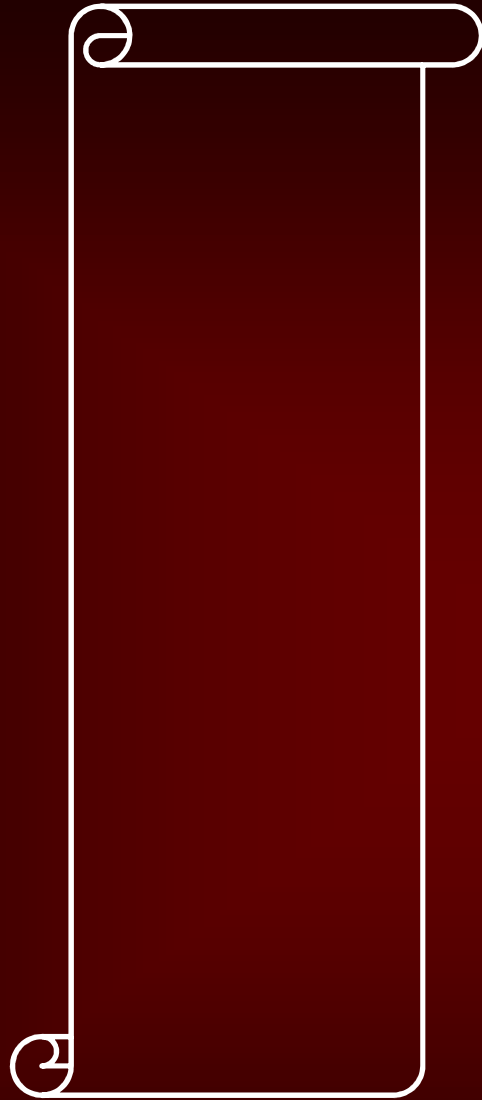
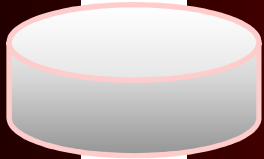

„Du sollst dem Herrn, deinem Gott, huldigen

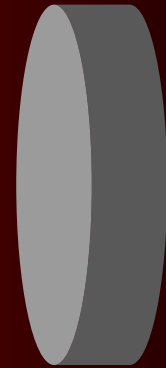
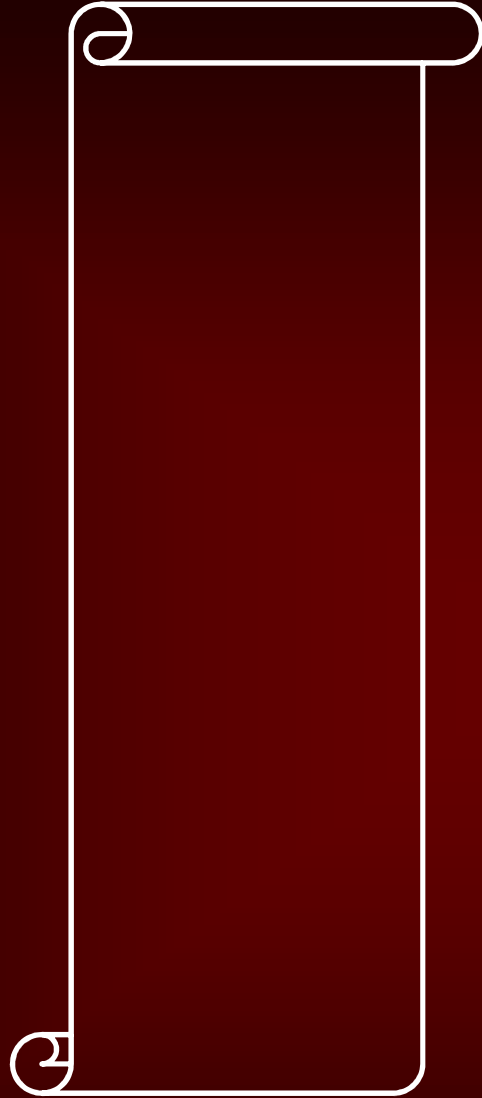
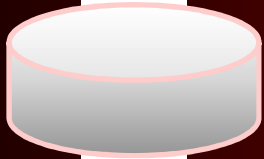

und ihm allein dienen“

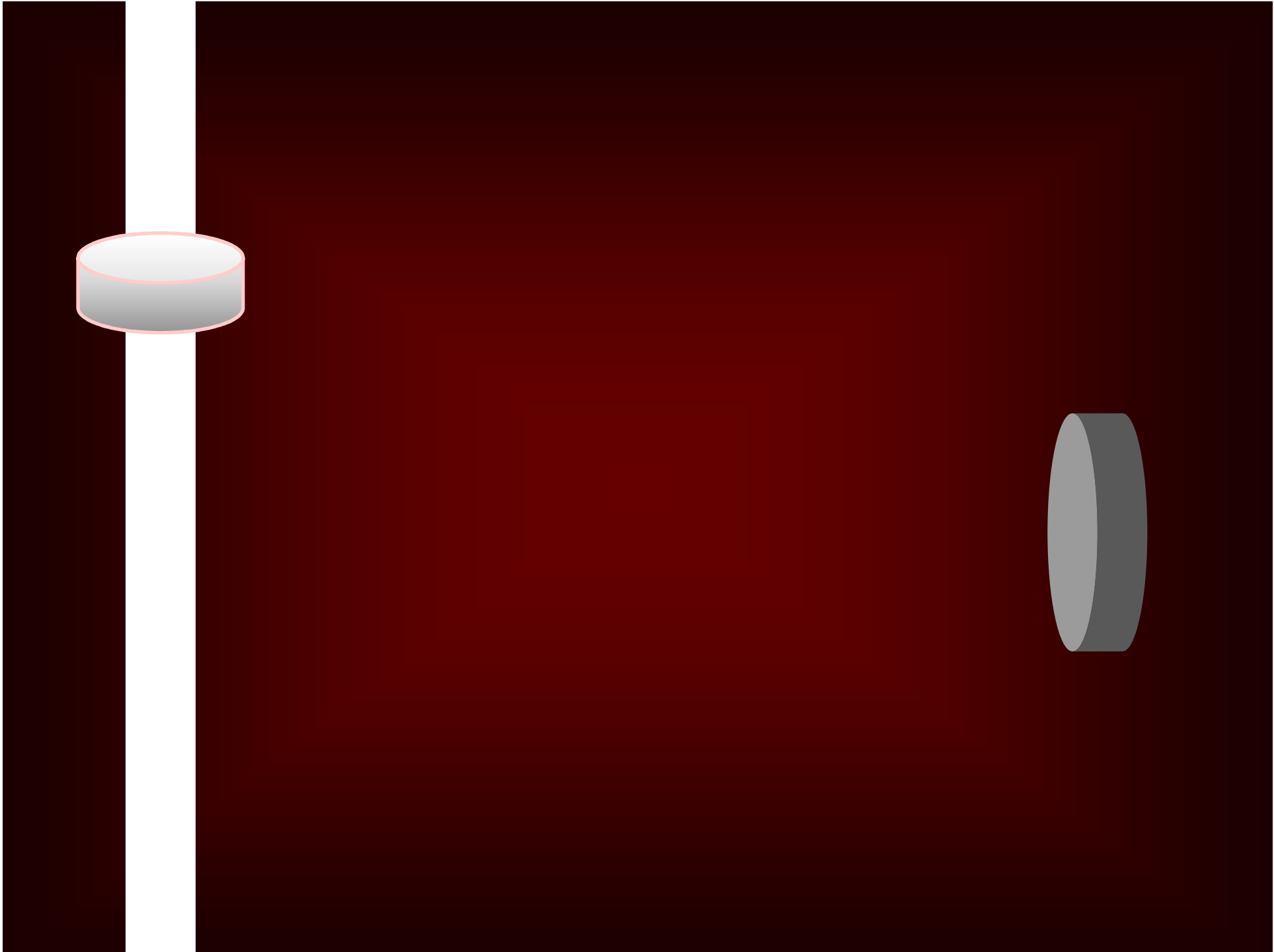

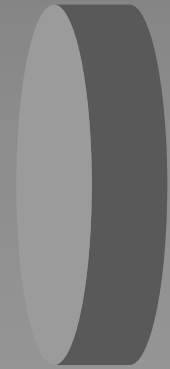
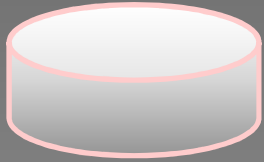

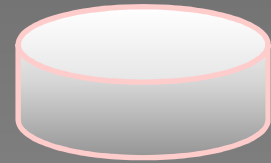

Da führte er ihn nach Jerusalem

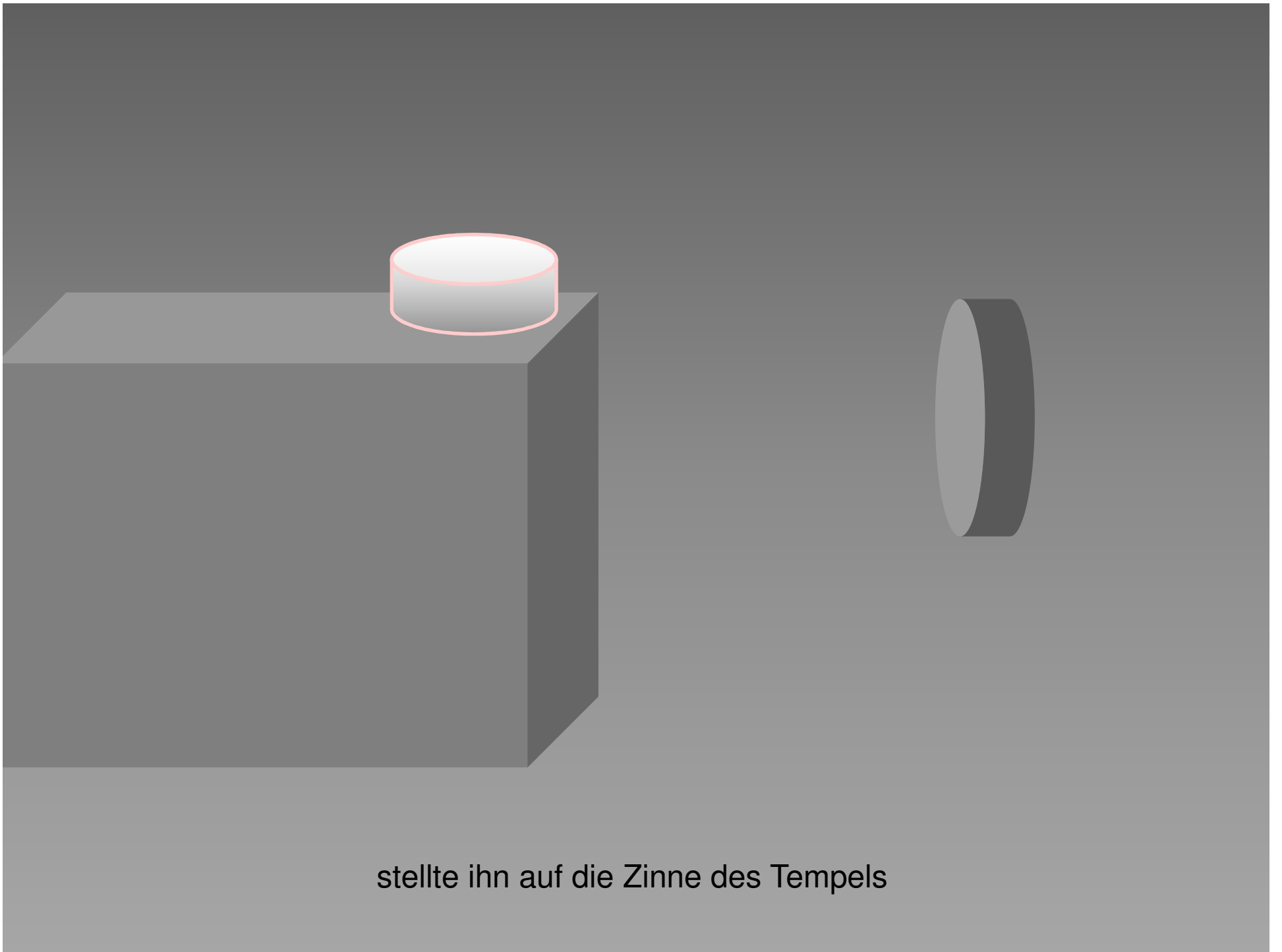

stellte ihn auf die Zinne des Tempels

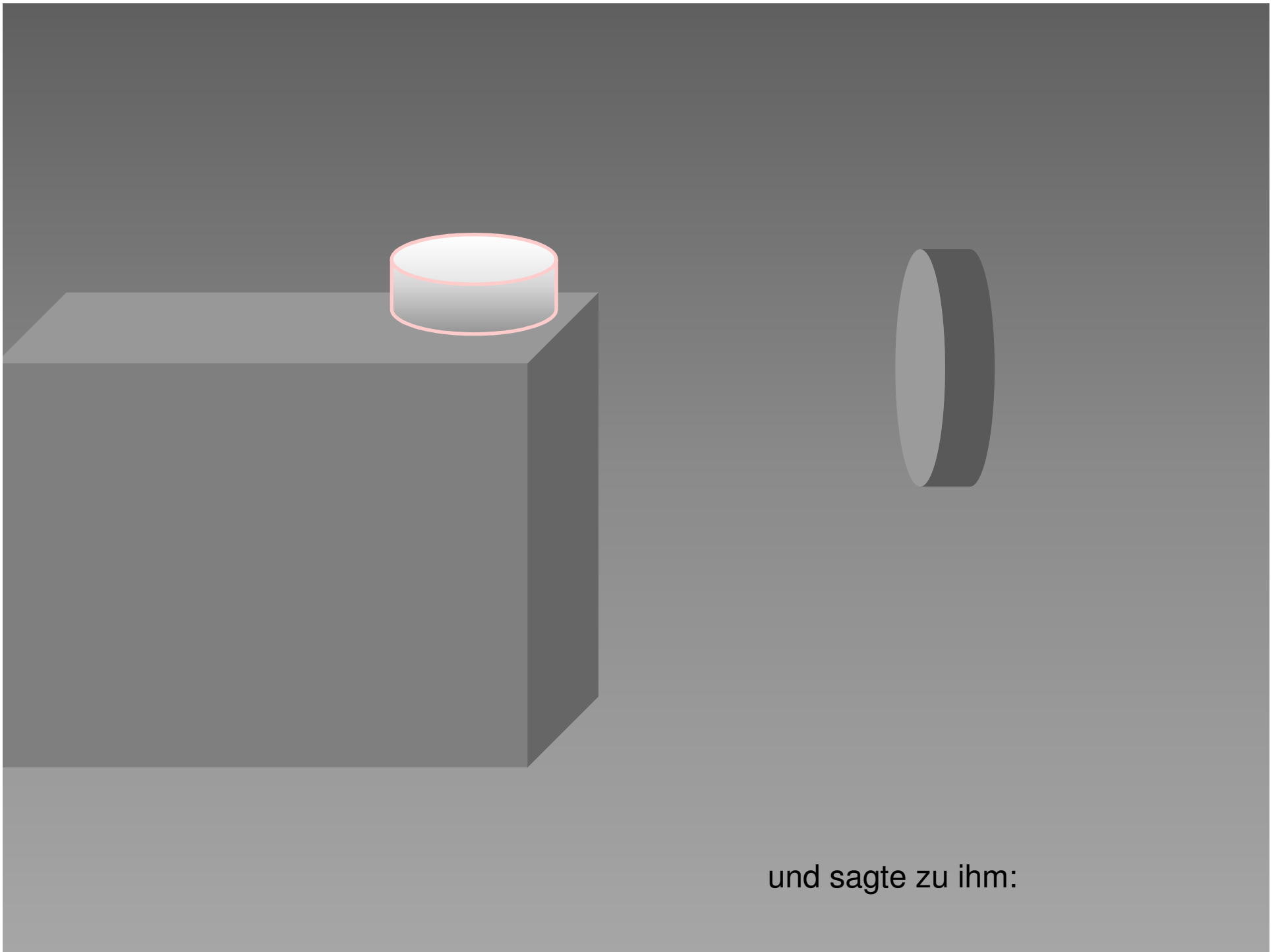

und sagte zu ihm:



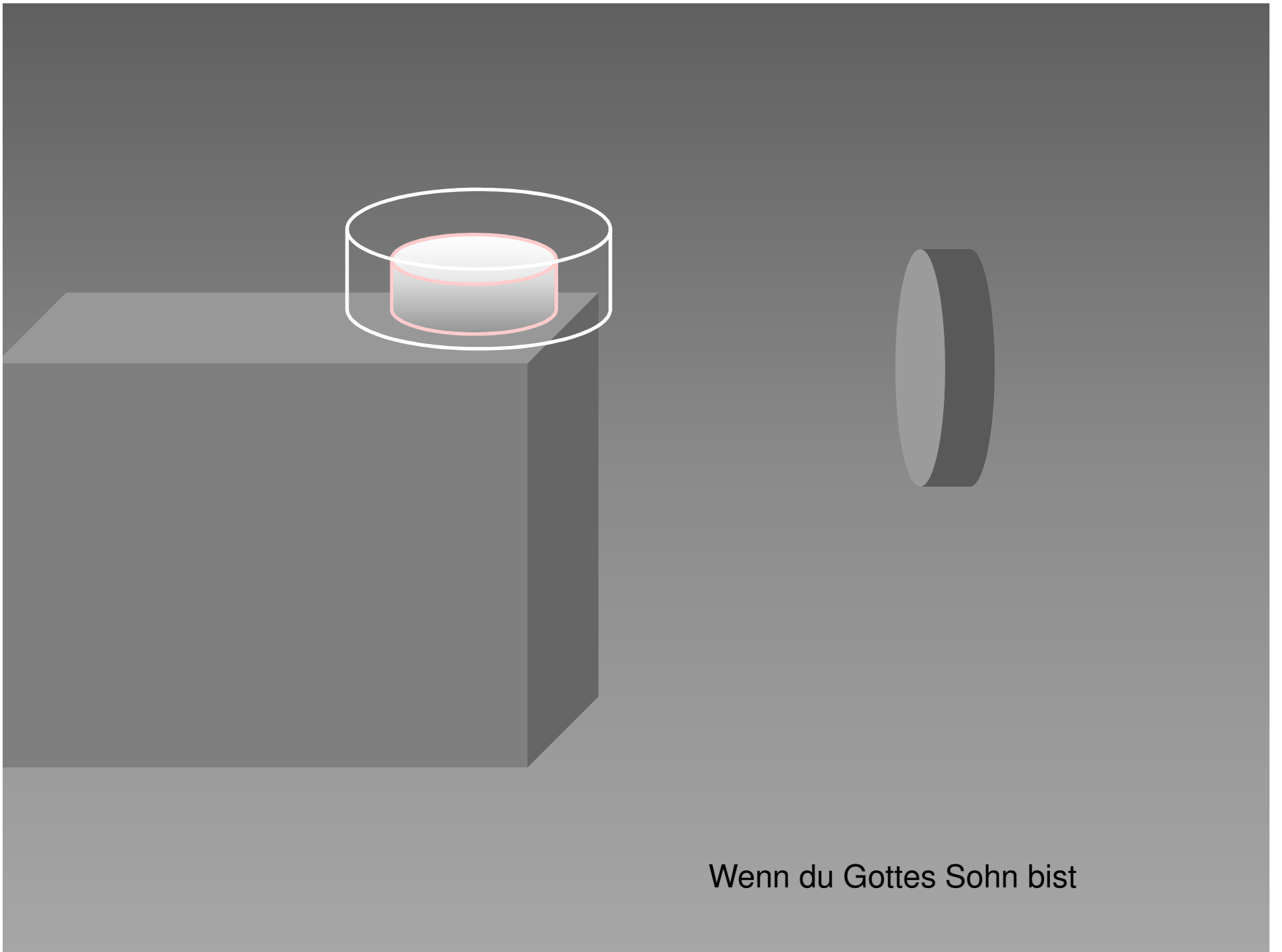

Wenn du Gottes Sohn bist

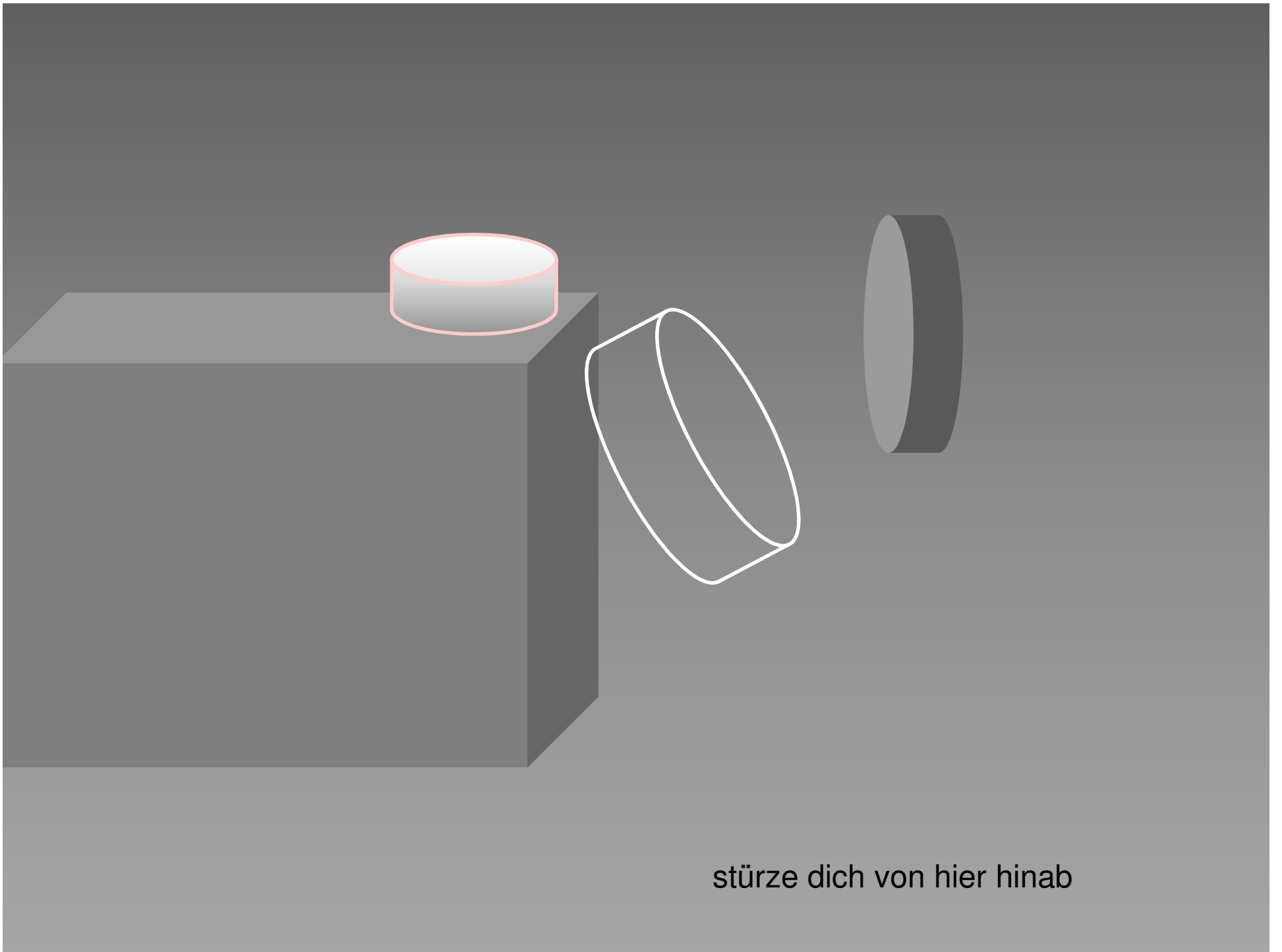

stürze dich von hier hinab

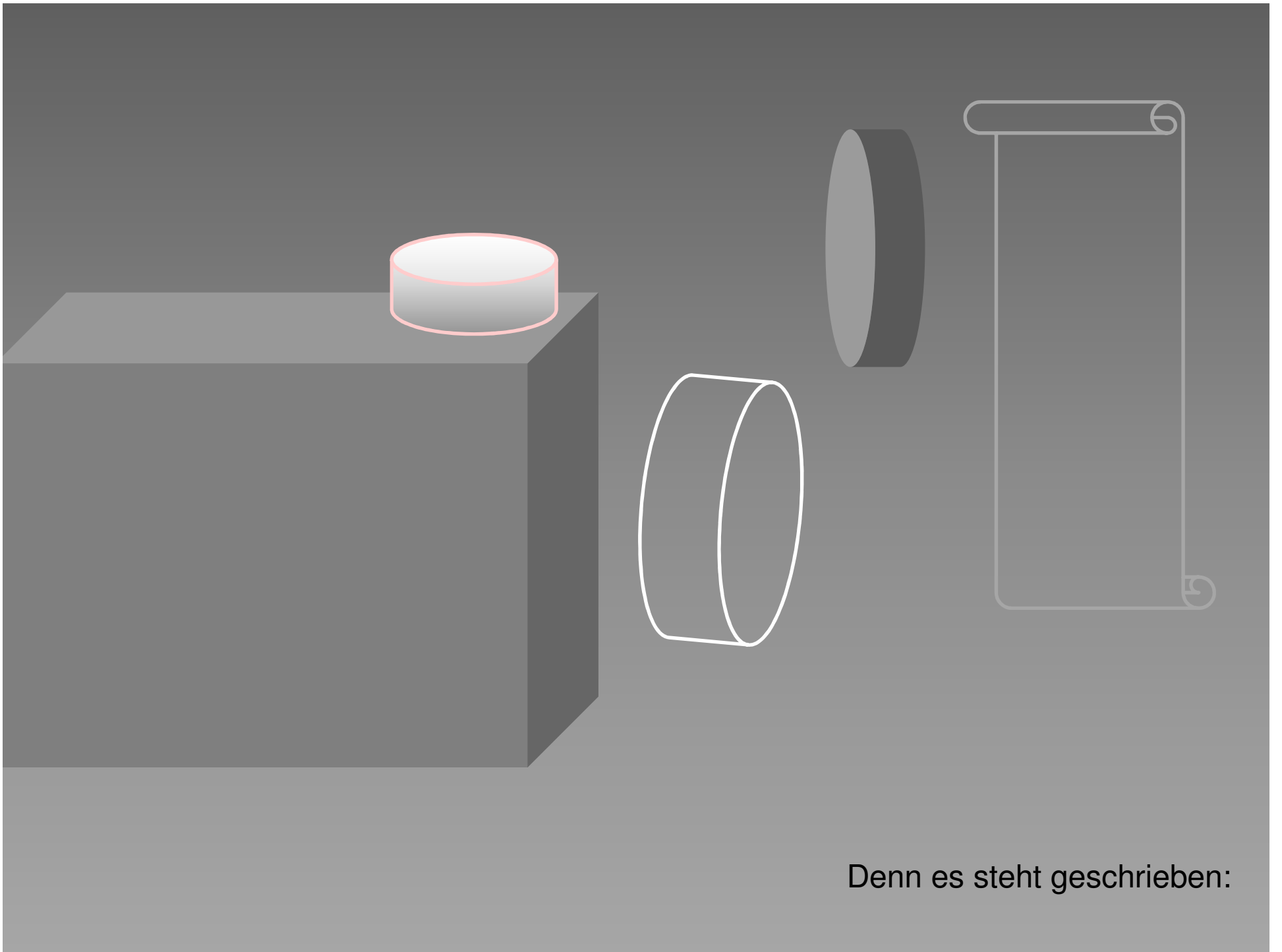

Denn es steht geschrieben:

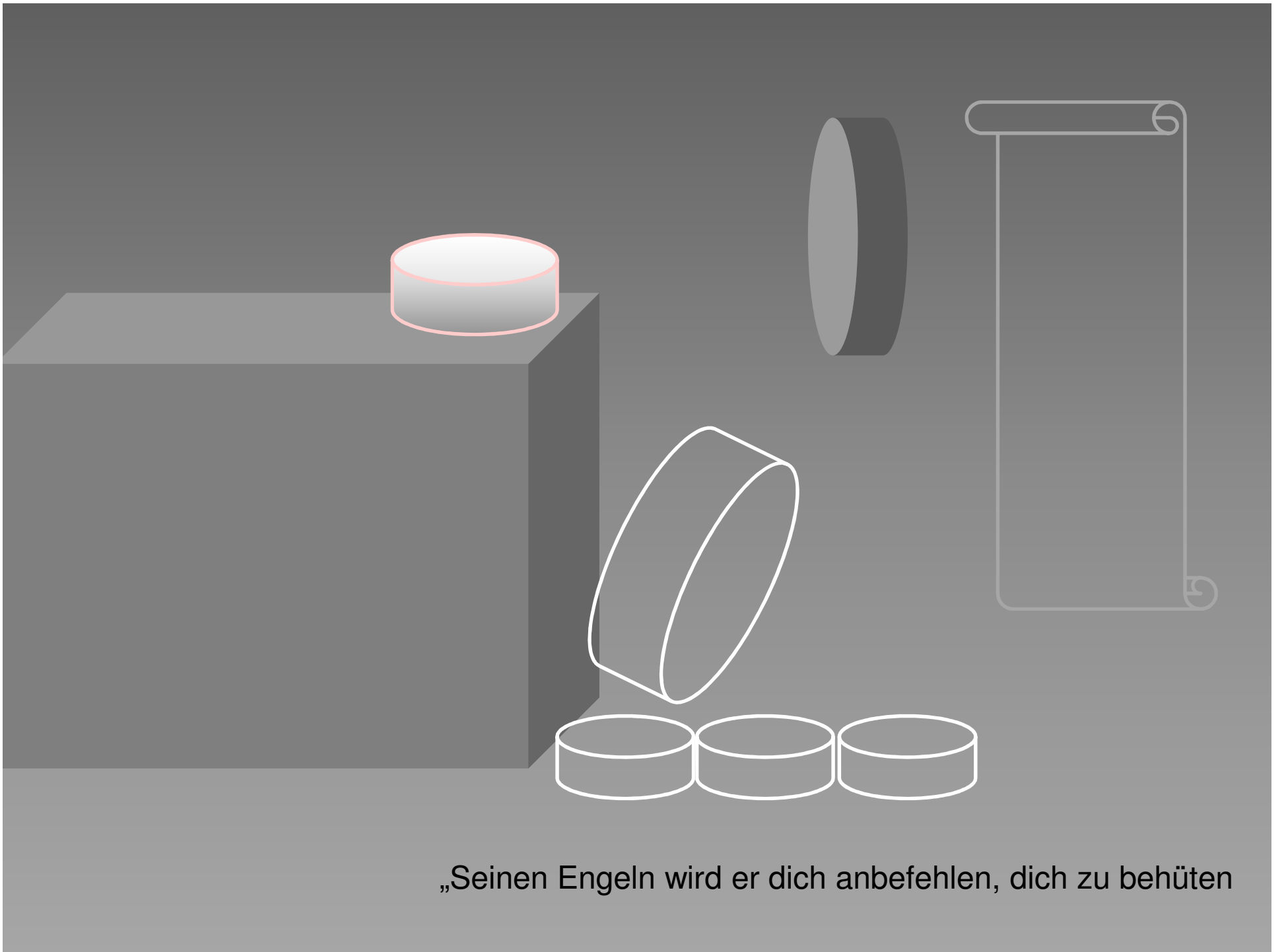

„Seinen Engeln wird er dich anbefehlen, dich zu behüten

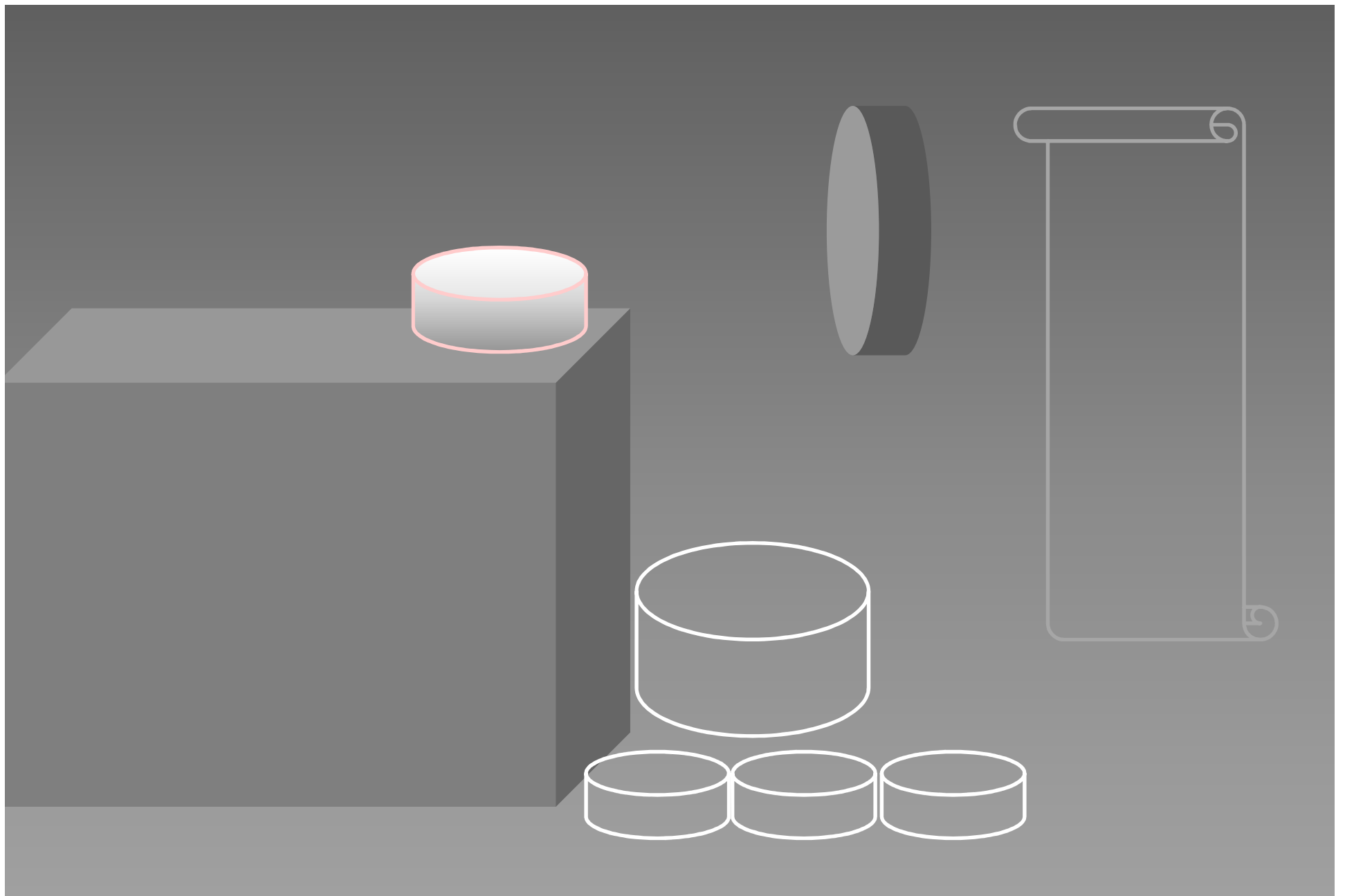

Auf den Händen werden sie dich tragen, damit du deinen Fuß an keinen Stein stoßest“

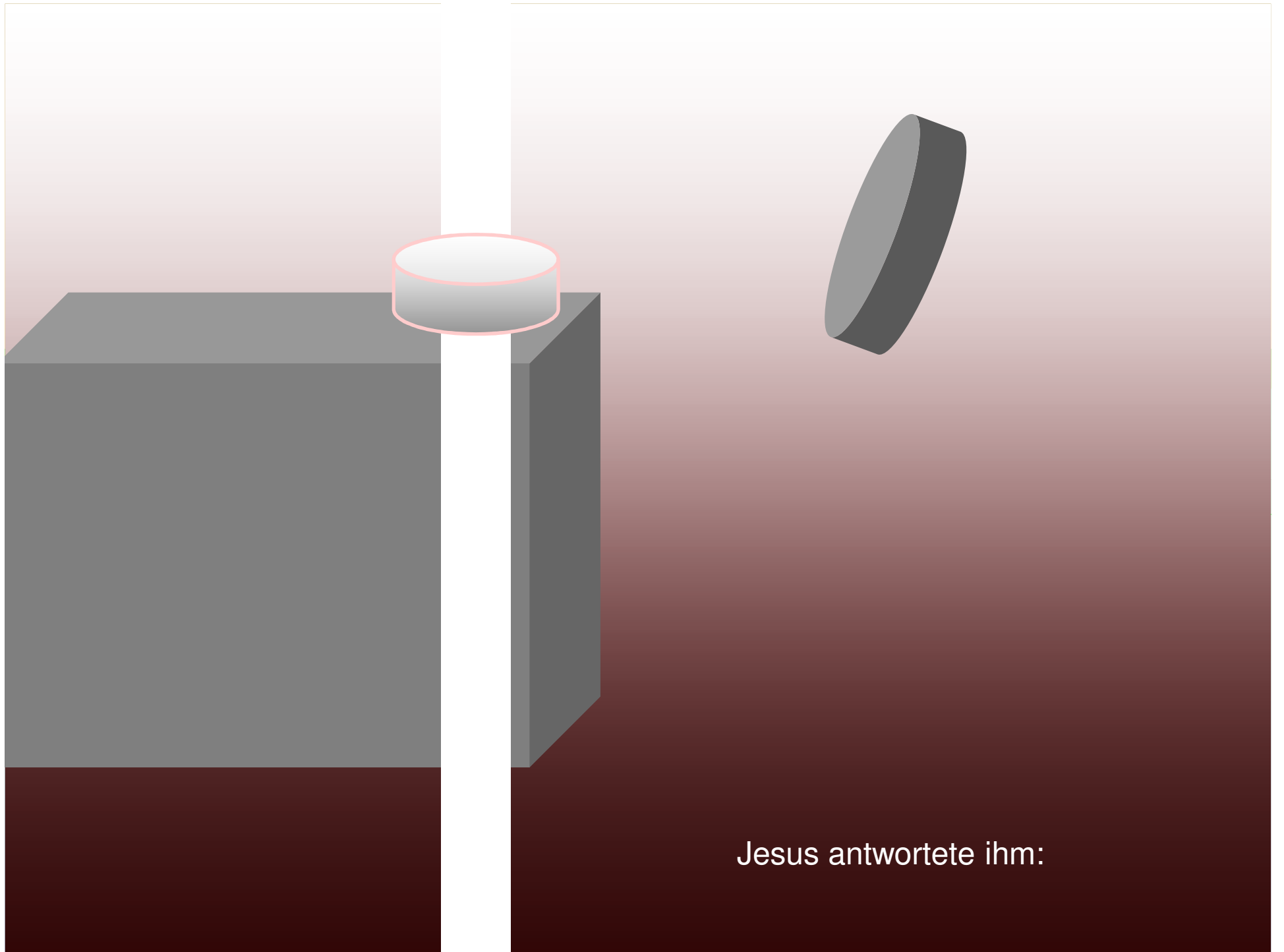

Jesus antwortete ihm:

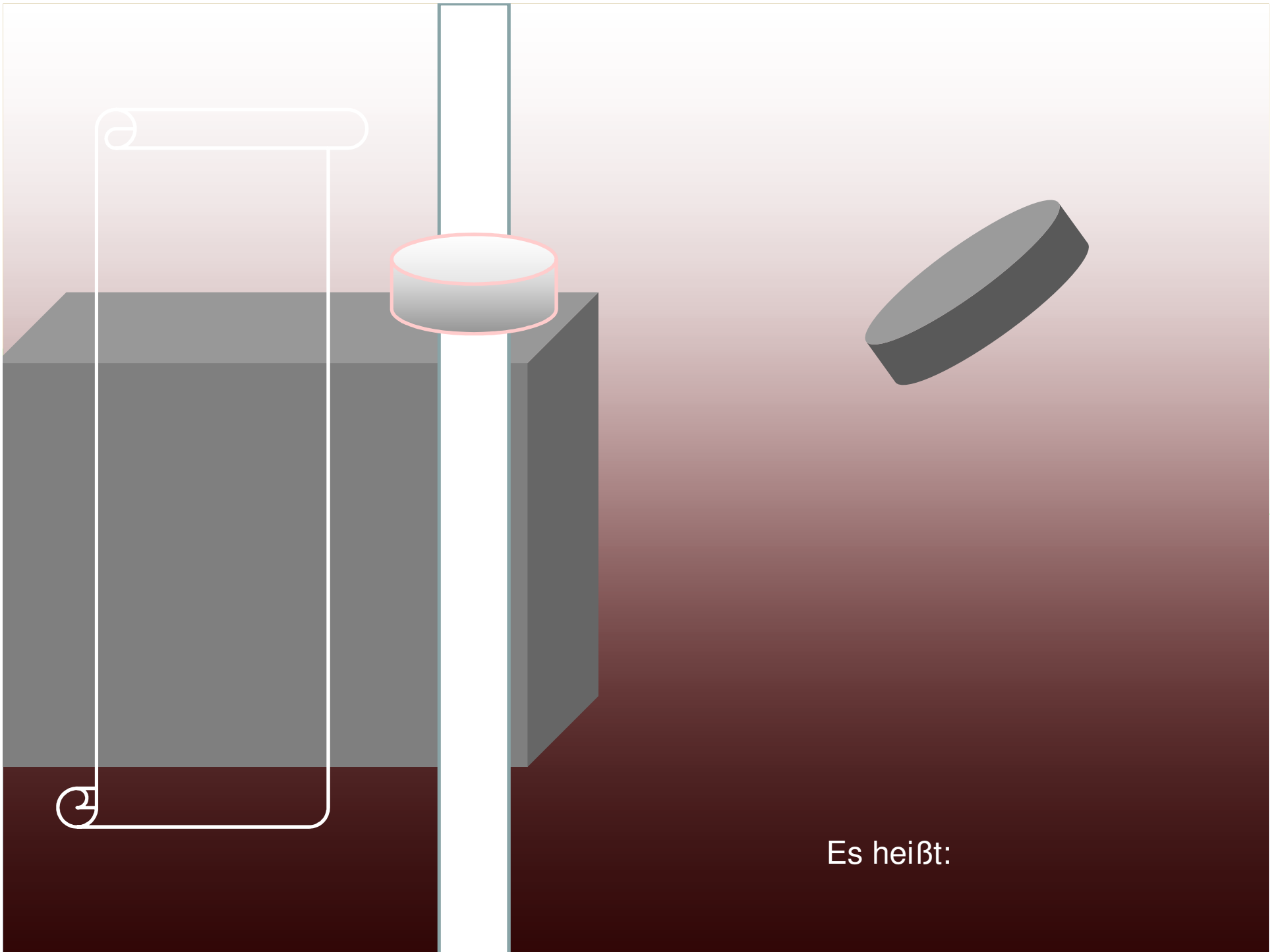

Es heißt:

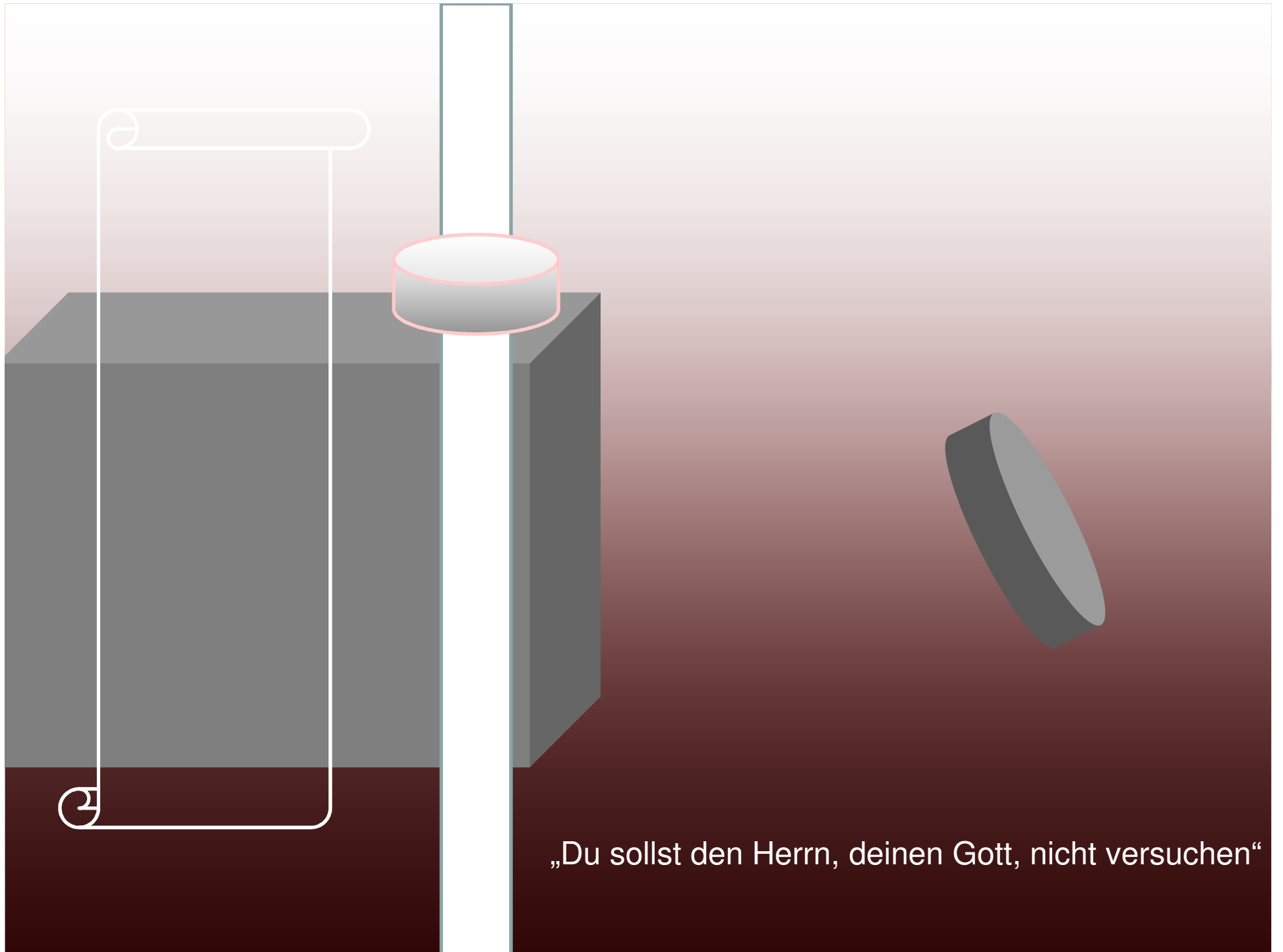

„Du sollst den Herrn, deinen Gott, nicht versuchen“



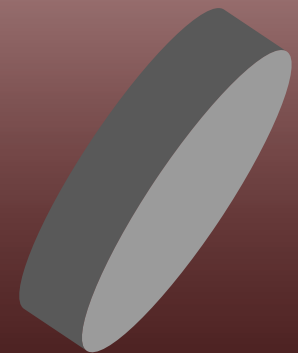
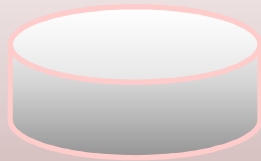

Und als der Teufel mit aller Versuchung zu Ende war

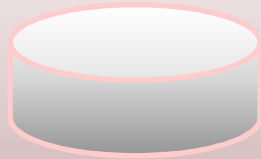

ließ er ab von ihm bis zu seiner Zeit



